

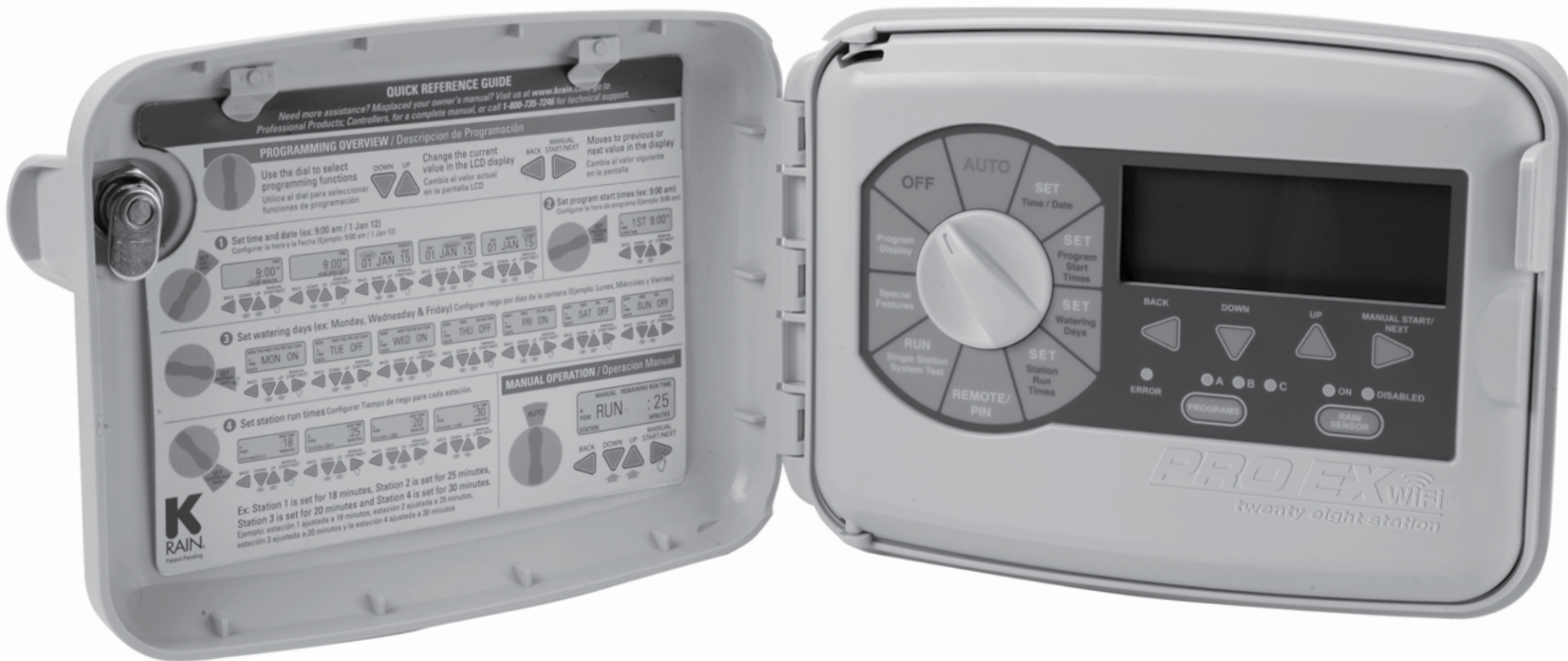

PRO EX 2.0

WIFI ENABLED MODULAR CONTROLLER *twenty eight station*



INSTRUCTION MANUAL

DECLARATION OF CONFORMITY

This unit has been designed to provide reasonable protection against harmful interference in a residential install. This equipment uses, generates and can radiate radio frequency energy and, if not installed and used in accordance with the instructions, may cause harmful interference to radio communications. There is no guarantee that interference will not occur in any particular install.

If the equipment does cause harmful interference to radio or television reception, which can be determined by turning the equipment off and back on again, the user is encouraged to try to correct the interference by: (1) reorient or relocate the receiving antenna; (2) increase the separation between the equipment and receiver; (3) connect the equipment into an outlet on a different circuit from the receiver; (4) consult the dealer or an experienced radio / TV technician for help.

Changes or modifications to this equipment could void the user's authority to use the equipment as well as the warranty.

INTRODUCTION

The Pro EX 2.0 WiFi Enabled Controller is available as indoor or outdoor models, with both modules utilizing a WiFi enabled Hub. The unit consists of a master valve/pump start, test, common, sensor terminals and one factory installed module which will operate four electric valves. The controller is expandable by installing separately purchased four or fourteen station modules which are installed internally in the controller.

In addition, the WiFi enabled controller includes a separated WiFi Hub (Photo), RF Module (Installed in Controller) and optional Long-Range Antenna.

CONTENTS

Controls and Touch Pad	03	▶ Permanent Day Off	23
Connecting to Wi-Fi	04	▶ Set Flow Meter	24
▶ For iOS	04	▶ Set Optional Hi/Lo Flow Limits	25
▶ For Android	07	▶ Setting by Program	26
How to share controller	10	▶ Setting by Zone	27
▶ Contractor	10	▶ Flow History	28
▶ Homeowner	11	▶ Set Flow Units	29
Setting the Controller to Off	12	▶ See Live Flow Data	30
Set Controller to Run Automatically	12	▶ Possible Alarm Displays	31
Program Select Button	12	Program Display	32
Rain Sensor Select Button	13	Resetting the Controller	32
Programming	13	Installation	33
▶ Set Time/Date	14	▶ Door Removal	33
▶ Set Program Start Times	14	▶ Main Panel Removal	33
▶ Set Watering Days	15	▶ Mounting the Controller	34
▶ Set Custom Operation (Any day of the week)	15	▶ Installing a 4 Station Module	35
▶ Set Odd/Even Operation (Calendar day)	15	▶ Installing a 14 Station Module	35
▶ Set Cyclic Watering Cycle	16	▶ Module Layout Combinations	36
▶ Set Station Run Times	16	▶ Installing a 14 Station Module	37
Manual Program Operation	17	▶ Connecting Valve Wires	37
Remote/Pin	17	▶ Connecting the Flow Sensor	37
Running a Single Station Manually	18	▶ Pump Start/Master Valve Wiring	38
Valve Locator	18	▶ Rain Sensor Installation	38
Test All Stations	19	Remote Programming	39
Special Features	20	Powering the Controller	39
▶ Seasonal Adjust	20	Specifications	40
▶ Station Delay/Overlap	20	▶ Operating Specifications	40
▶ Pump On/Off	20	▶ Electrical Specifications	40
▶ Sensor	21	▶ Dimensions	40
▶ Open Circuit Detection	21	Troubleshooting	41
▶ Clear	21	Quick Programming Reference Guide	42
▶ Save	22	Spare Watering Planner	43
▶ Restore	22	Warranty	44
▶ Display Contrast	22		

CONTROLS AND TOUCH PAD

LCD DISPLAY

- ① Displays the time of day and day of the week
- ② During programming shows the results of entered commands
- ③ During watering shows the valve that is on and the minutes remaining in its run time

PROGRAM DIAL

- ① Used to turn the controller on and off and to program.
- ② Used to run on Automatic and to discontinue watering (OFF)
- ③ Used to select desired controller setting functions (SET)
- ④ Shows total content of a program (PROGRAM DISPLAY)
- ⑤ Used to set personalized Pin Number (REMOTE/PIN) and pair controller with WiFi Hub
- ⑥ Used to allow setting controller special features (SPECIAL FEATURES)
- ⑦ Used to run single stations or system test cycles (RUN)

MANUAL START / NEXT BUTTON

Used to start a selected irrigation program manually, or to manually advance watering from one station valve to the next.

ERROR/ALARM LED

Turns on when one of the following occurs:

- ① Watering is suspended by a sensor
- ② The controller senses a valve short circuit
- ③ A programming error has been made.

DOWN / UP BUTTONS

Used to set time / date and to make program changes.

PROGRAM SELECT BUTTON

Used to select watering program A, B or C.

SENSOR BYPASS SELECT BUTTON

Used to tell the controller to obey or ignore sensor input.

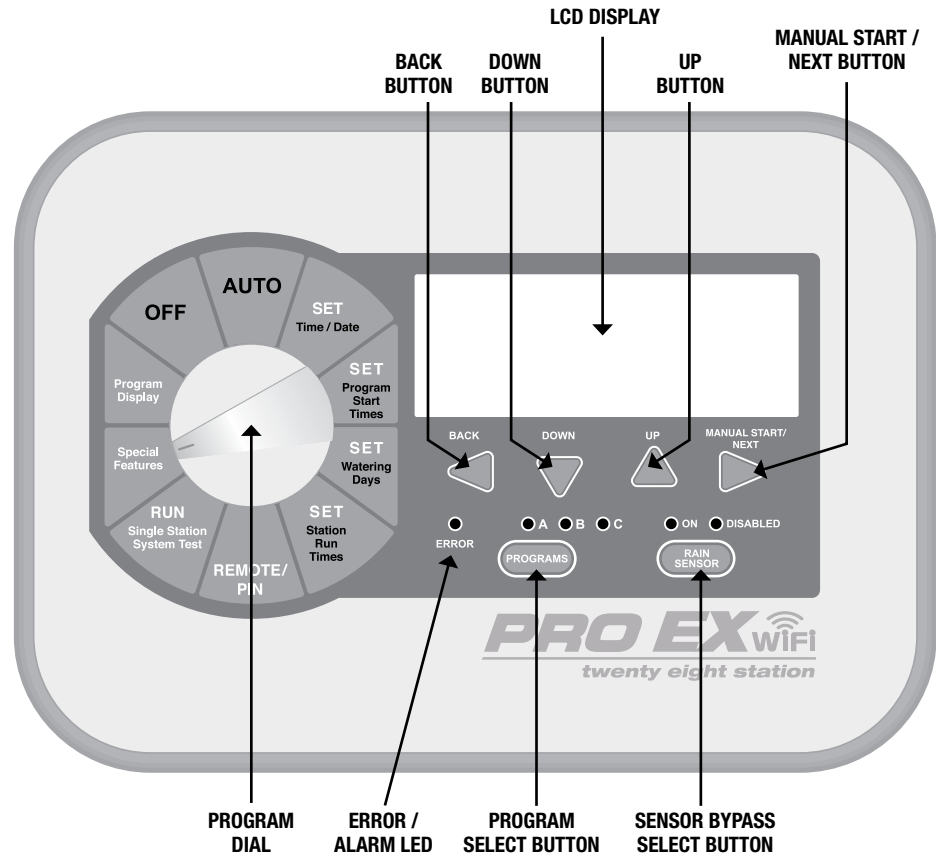

CONNECTING TO WI-FI : IOS

! IMPORTANT: Use only the power supply provided.

ITEMS NEEDED:

1. Pro Ex 2.0 WiFi Enabled Irrigation Controller
2. RF Module
3. WiFi Hub

Powering and Placing your WiFi Hub:

- A) Pick a dry location inside the home or in the garage with good WiFi signal strength. An easy way to evaluate signal strength is using the WiFi signal indicator on your smartphone or tablet; the icon should be full. **Do not place hub next to large metal appliances, e.g. hot water heater, air conditioning unit, etc.
- B) After plugging the power to the WiFi Hub, the “K” LED light should be flashing (On/ Off). This may take several seconds.

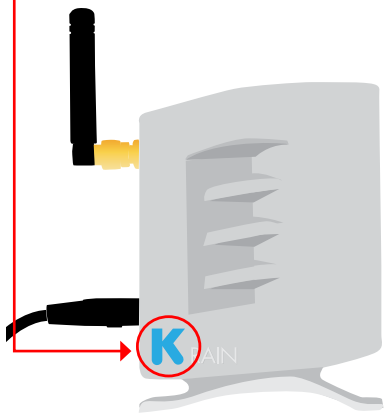

NOTE: If the LED is not flashing, reset the hub using the setting button located on the bottom base of the unit. The “K” LED should start flashing (On / Off) after holding down the button for three seconds.

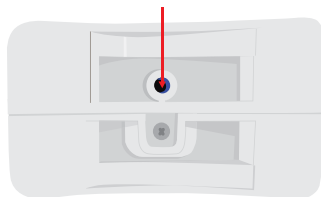

Creating a User Account and Connecting the Wifi Hub to the Controller for the first time using an iOS Device:

STEP 1

Download the K-Rain Pro EX App from the itunes App Store.



STEP 2

Click on “Create Account” Button.

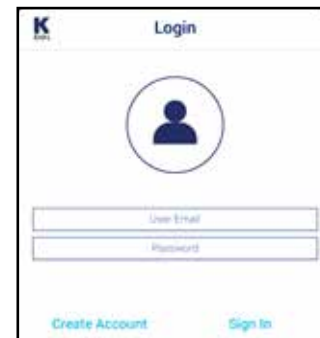

STEP 3

Enter an e-mail address.
Note: Password must be at least 6 characters long.

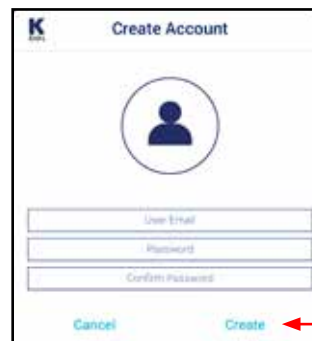

STEP 4

Enter user information. Note: Smartphone or tablet MUST be connected to the WiFi network in order to connect the WiFi Hub.



STEP 5

Reminder screen. After following procedure indicated, click Next.

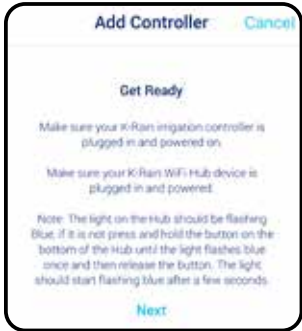

STEP 6

Connect app to K-Rain WiFi network.*

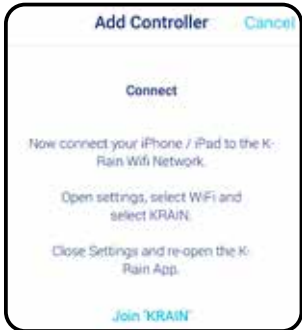

*Note: For dual-band routers, make sure your smartphone/tablet is connected to a 2.4GHz WiFi Network. This device is not compatible with 5GHz WiFi signals.

CONNECTING YOUR CONTROLLER TO THE WIFI HUB:

STEP 7

Go to the Pro Ex 2.0 controller faceplate. Move the dial to the REMOTE/PIN location.



Press UP button until you see NO WiFi on controller LCD.

Press MANUAL START/NEXT button and it will start searching for the WiFi Hub.



When the display shows "YS WiFi" on the LCD, it has been paired with the WiFi Hub.



STEP 8

Go back to K-Rain Pro EX 2.0 WiFi Controller App. It will show this screen as a reminder that the Controller and WiFi hub had to be paired before going to the next step.

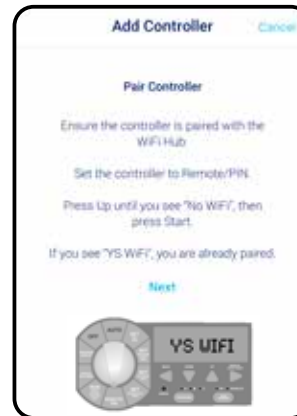



CONNECTING TO WI-FI : IOS

Connecting your WiFi Hub to your Router:

STEP 9

Enter home network WiFi Network (SSID) and password. Click configure controller.



STEP 10

Confirmation Screen. **Wait a few minutes for the WiFi Hub to connect to the Cloud.** At this point, the blue light on Hub should stop flashing and become solid. If blue light is not solid, has gone out or still flashing, click "Try Again", follow instructions.



STEP 11

Name your controller, and complete the address location. Click next.

NOTE: It is important to completely fill in address for Weather Forecast and Weather IQ™ accuracy.



STEP 12

Congratulations on connecting your WiFi controller. Click DONE.



Troubleshooting Guide

LED Indication	BLUE	GREEN	RED
ACCESS POINT (AP) Mode: WiFi Hub is on AP mode (for device setup).	Flashing	OFF	OFF
RF Communication OK: WiFi Hub Authenticating with user WiFi Router.	OFF	Flashing	OFF
RF Communication OK: WiFi connected to local user router successfully. Pending to connect to K-Rain server.	OFF	ON	OFF
RF Communication OK: WiFi connection to web server OK.	ON	OFF	OFF
RF Communication Error: Momentary or constant inadequate RF communication.	OFF	OFF	ON



CONNECTING TO WI-FI : ANDROID

⚠ IMPORTANT: Use only the power supply provided.

ITEMS NEEDED:

1. Pro Ex 2.0 WiFi Enabled Irrigation Controller
2. RF Module
3. WiFi Hub

Powering and Placing your WiFi Hub:



- A)** Pick a dry location inside the home or in the garage with good WiFi signal strength. An easy way to evaluate signal strength is using the WiFi signal indicator on your smartphone or tablet; the icon should be full. ****Do not place hub next to large metal appliances, e.g. hot water heater, air conditioning unit, etc.**
- B)** After plugging the power to the WiFi Hub, the “K” LED light should be flashing (On/ Off). This may take several seconds.

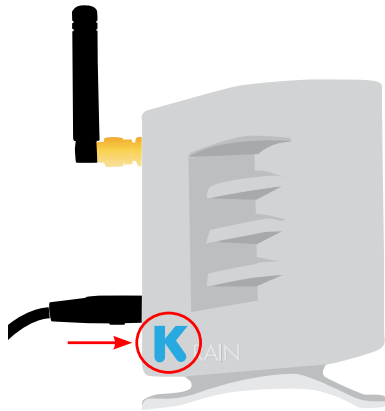

NOTE: If the LED is not flashing, reset the hub using the setting button located on the bottom base of the unit. The “K” LED should start flashing (On / Off) after holding down the button for three seconds.

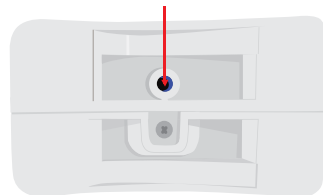

Creating a User Account and Connecting the Wifi Hub to the Controller for the first time using an Android Device:

STEP 1

Download the K-Rain Pro EX App from the itunes App Store.



STEP 2

Click on “Create” Button. Note: Password must be at least 6 characters long.

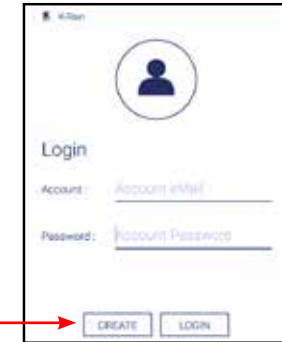

STEP 3

Enter an e-mail address.

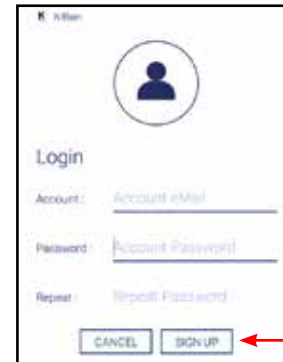

STEP 4

Enter user information. Note: Smartphone or tablet **MUST** be connected to the WiFi network in order to connect the WiFi Hub.





CONNECTING TO WI-FI : ANDROID

STEP 5

Reminder screen. Enter user information. After following procedure indicated, click Next.*

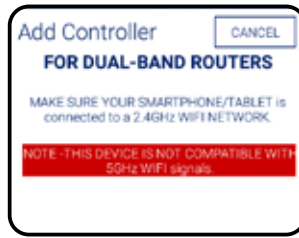

*Note: For dual-band routers, make sure your smartphone/tablet is connected to a 2.4GHz WiFi Network. This device is not compatible with 5GHz WiFi signals.

CONNECTING YOUR CONTROLLER TO THE WIFI HUB:

STEP 6

Go to the Pro Ex 2.0 controller faceplate. Move the dial to the REMOTE/PIN location.

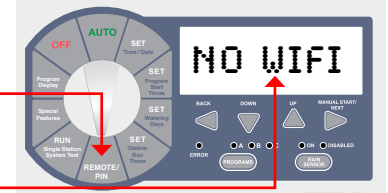

Press UP button until you see NO WiFi on controller LCD.

Press MANUAL START/NEXT button and it will start searching for the WiFi Hub.



When the display shows "YS WiFi" on the LCD, it has been paired with the WiFi Hub.



STEP 7

Go back to K-Rain Pro EX 2.0 WiFi Controller App. It will show this screen as a reminder that the Controller and WiFi hub had to be paired before going to the next step.



Connecting your WiFi Hub to your Router:

STEP 8

Enter home network WiFi Network (SSID) and password. Click configure controller.



STEP 9

Confirmation Screen. Wait a few minutes for the WiFi Hub to connect to the Cloud. At this point, the blue light on Hub should stop flashing and become solid. If blue light is not solid, has gone out or still flashing, click "Try Again", follow instructions.



STEP 10

Name your controller, complete address location of this controller. Click next.



Note: It is important to completely fill in the address for Weather Forecast and Weather IQ™ accuracy.

STEP 11

Congratulations on connecting your WiFi controller. Click DONE.



Troubleshooting Guide

LED Indication	BLUE	RED
ACCESS POINT (AP) Mode: WiFi Hub is on AP mode (for device setup).	Flashing	OFF
RF Communication OK: WiFi Hub Authenticating with user WiFi Router.	OFF	Flashing
RF Communication OK: WiFi connected to local user router successfully. Pending to connect to K-Rain server.	OFF	ON
RF Communication OK: WiFi connection to web server OK.	ON	OFF
RF Communication Error: Momentary or constant inadequate RF communication.	OFF	ON

For additional support, please visit: support.krain.com/support/home

HOW TO SHARE CONTROLLER

► CONTRACTOR | Adding a Pro Ex 2.0 WiFi Controller to Your Account

- Register for a professional account at: www.krain.com/proexcontractor
- **NOTE:** The homeowner must enable the share feature via their account prior to adding a controller to the contractor's account.
- Ask the homeowner to complete the contractor information card included for you.

WEBSITE METHOD:

To add a controller via web browser:

- 1) Go to myproex.krain.com and login
- 2) Select "My Account" page
- 3) Enter **MAC Address** printed on WiFi Hub - Click ADD
- 4) Refresh Screen

The controller should now appear. MANAGE allows you to log into that controller and modify settings.
If controller does not appear, contact the homeowner and ask them to share via the instructions provided.

The screenshot shows the 'My Account' page with the following details:

- Contractor-1
- Irrigation and Landscape
- 234-567-8910
- contractor@email.com
- Password
- Enter your full address*
- 1234 Anystreet way
- Anytown
- FL 12345
- United States

Below the details is a section titled 'Connect to other controllers' with a search bar and a table of existing controllers:

Search by Name, MAC, Phone, Address	
🔍	On Active Delete
🔍	On Manage Delete
🔍 MAC Address	Add

Buttons for 'Save' and 'Cancel' are at the bottom.

FROM NATIVE iOS/ANDROID App:

You should receive an email from **the homeowner** with an attachment.

If you have the App installed, simply tap on the attachment to install:

If you do not receive the email, please check spam and then contact the homeowner.

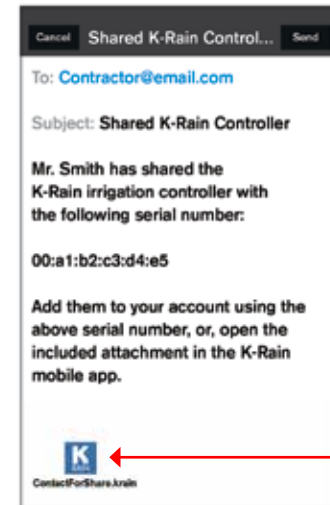

▶ HOMEOWNER | SHARING YOUR PRO EX 2.0 WIFI CONTROLLER

- Download the K-Rain Pro EX WiFi App from the iTunes or Google Play App Store.
- Complete the homeowner and contractor information cards included and give the card to your contractor.



itunes
iOS App



Google Play
Android App



Website method:

Go to myproex.krain.com and log into your account. In the “My Account” page.

Click “Share” next to your controller and then save.

The contractor will then be able to add your irrigation controller to their account based on the information documented (MAC Address) during controller installation.

Email share method:

If you have email set up on your smart phone, you can share your controller by tapping “Share” in the App on the Account Page.

Tap “Share Controller” and enter contractor’s email address from the completed information card. Tap “Share” underneath the email address field.



The App will generate a share file in an email and send it directly to the contractor.

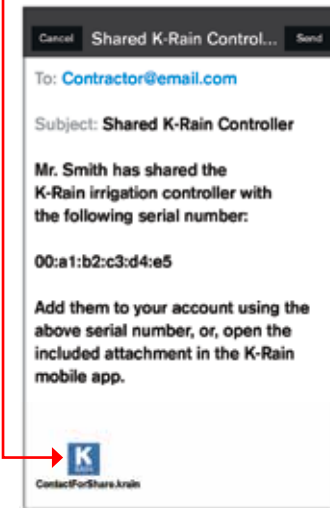

SETTING THE CONTROLLER TO OFF

1. Turn the dial to “OFF”

When the dial is in the “OFF” position no watering occurs. The display will show “OFF,” the time of day and day of the week.

If the OFF position has been bypassed via iOS or Android App or via web browser, the unit will display BYPASS WiFi. To turn the controller OFF, simply turn the dial to AUTO then back to OFF.

NOTE: Pressing any button will momentarily display the current “Revision Number,” “K-RAIN” or full display screen.

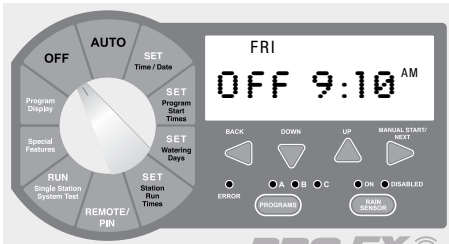

SET CONTROLLER TO RUN AUTOMATICALLY

1. Turn the dial to “AUTO”

When the dial is in the “AUTO” position the controller will run in automatic mode. The display will show the selected program, the day of the week and the time of day. The controller will turn on automatically to meet ANY programmed water schedules.

If the controller has been turned OFF via iOS, Android or web browser, the display will show BYPASS WiFi. Simply turn the dial to OFF then back to AUTO to make the controller run in AUTO mode.

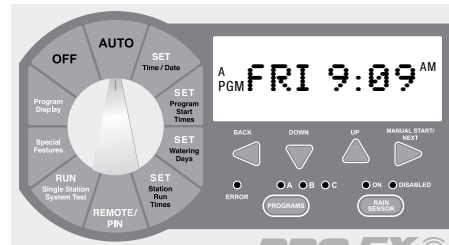

PROGRAM SELECT BUTTON

The Pro EX 2.0 controller has three separate programs, A, B and C. Multiple programs allow valves automatic operation with different watering days and start times.

You can program any valve to run in one or more of the three programs.

1. To select a program, touch the PROGRAM select button on the front panel to select program A, B or C.
2. The display briefly shows the program selected.
3. The selected program then appears on the left side of the display.
4. Any programming instructions entered will apply only to the selected program.

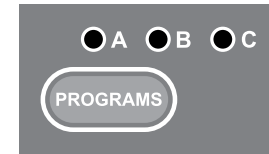

RAIN SENSOR SELECT BUTTON

The purpose of a rain sensor is to stop automatic watering when sufficient precipitation has been reached.

The rain sensor select button allows the user to bypass the rain sensor. If a rain sensor has been installed, and BYPASSED has been selected, then BYPASSED will be displayed in the upper left corner of the LCD.

NOTE: When the rain sensor select button is in the ON position a rain sensor or wire jumper must be installed in order to run a program.

Refer to page 19 for further details.

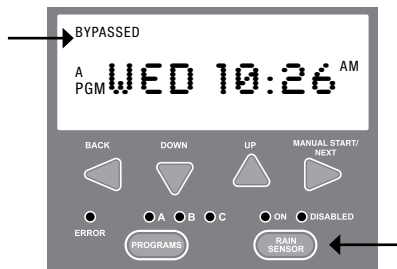

PROGRAMMING

A key feature of the Pro EX 2.0 controller is its large easy-to-read LCD display. The display is also backlit when primary power is being supplied to the controller, and if any buttons are pushed, or if the program or controller is being accessed via smartphone, tablet or web browser.

As the program dial is rotated the display automatically changes. The flashing value within the display can be increased or decreased by pressing the DOWN or UP buttons. To go back or advance to the next value press the BACK or NEXT buttons.

Because of variations in plant watering needs the Pro EX 2.0 controller has three separate programming options A, B and C. Each program is completely independent of each other and the controller will automatically stack programs that overlap. This allows for all programmed watering to occur because only one program will run at a time and in alphabetical order.

Only one start time per program (A, B or C) is required to operate all stations with a run time. The controller automatically and numerically advances operation to the next station without the need for additional start times.

For additional watering, each program can be set with up to four separate start times. This allows for greater irrigating efficiency when all watering can't be done during a single operation (cycle and soak).

NOTE: A program must contain at least one start time, watering day(s) and one station with a run time in order to operate.

SET TIME / DATE

1. Turn the dial to SET TIME / DATE, the LCD will display the time of day. The word “HOURS” will be flashing in the display.

NOTE: If the controller is connected to the internet via WiFi Hub, the server will push the correct time and date to the controller according to the controller address and zip code entered during set up.

2. Press the DOWN or UP buttons to set current hour.
3. To change minutes, press the NEXT button. The word “MINUTES” will be flashing in the display.
4. Press the DOWN or UP buttons to set current minutes.
5. To set the current date, press the NEXT button. The word “DAY” will be flashing in the display.

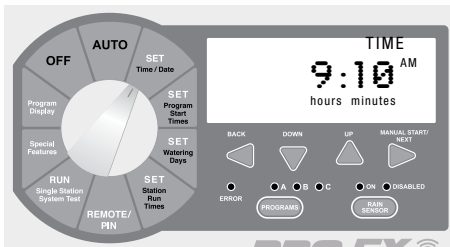

6. Press the DOWN or UP buttons to set current day.
7. To set the current month press the NEXT button and the word “MONTH” will be flashing in the display.
8. Press the DOWN or UP buttons to set the current month.
9. To set the current year press the NEXT button. The word “YEAR” will be flashing in the display.
10. Press the DOWN or UP buttons to set the current year.
11. Return the dial to AUTO.

NOTE: The Pro EX 2.0 controller can be set for either 12 or 24 hour display. Pressing the BACK and NEXT buttons SIMULTANEOUSLY will allow user to toggle between 12 or 24 hour display.

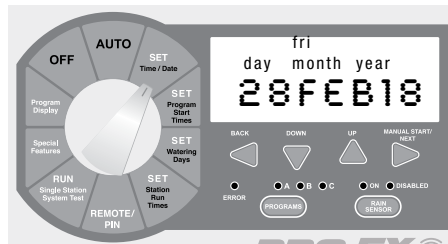

SET PROGRAM START TIMES

The Pro EX 2.0 controller will allow up to four separate watering start times for each program.

1. Use the PROGRAM select button to select the program (A, B or C) you wish to assign a start time.
2. Turn the dial to SET PROGRAM START TIMES. The display will show the first start time currently set for the selected program.
3. Press the DOWN or UP buttons to change the start time. The time setting change is in 15-minute increments.
4. To eliminate a watering start time press the DOWN or UP buttons until “OFF” appears in the display. The OFF setting is located between 11:45 p.m. and 12:00 a.m.
5. When additional start times are needed press the NEXT button to display the next watering start time. Repeat steps 4-6 for setting additional start times.
6. Return the dial to AUTO.

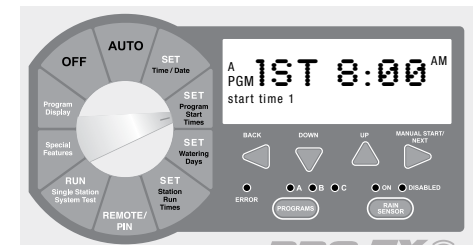

SET WATERING DAYS

The Pro EX 2.0 controller can be programmed to operate within four different watering cycles.

CUSTOM waters on the days of the week you select.

ODD waters only on odd number days of the month.

EVEN waters on even numbered days of the month.

CYCLIC waters on a selected daily interval (for example every 5 days).

SET CUSTOM OPERATION

1. Use the PROGRAM SELECT BUTTON to select the program (A, B or C) you wish to assign watering days.
2. Turn the dial to SET WATERING DAYS. "MON ON" should appear in the display.
3. Press the DOWN or UP buttons to enable (ON) or disable (OFF) day of the week operation.
4. Press the NEXT button to advance to the next day of the week. Repeat steps 3 and 4 until all days of the week have been set.
5. Return the dial to AUTO.

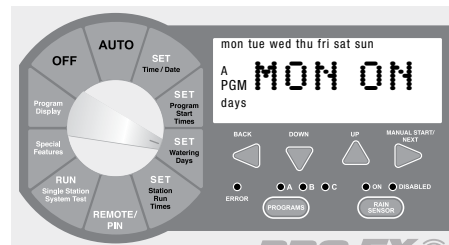

SET ODD/EVEN OPERATION

1. Use the PROGRAM SELECT BUTTON to select the program (A, B or C) you wish to assign odd or even watering.
2. Press the BACK and NEXT buttons SIMULTANEOUSLY until "ODD" or "EVEN" appears in the display.
3. Return the dial to AUTO.

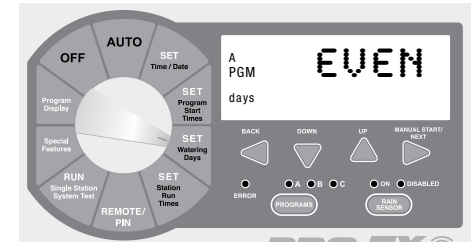
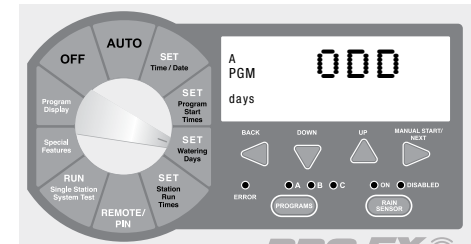

SET CYCLIC WATER CYCLE

1. Use the PROGRAM select button to select the program (A, B or C) you wish to assign cyclic watering.
2. Press BACK and NEXT buttons simultaneously until “CYCLE” appears in the upper right corner of the display and “DAYS REMAINING” in the lower left. “DAYS REMAINING” will be flashing.
3. The display shows the number of days remaining until the next watering day and the number of days in the cycle.
4. Press the DOWN or UP buttons to set the number of days remaining before the next automatic watering should begin.
5. Press the NEXT button to advance to “DAY CYCLE.” “DAY CYCLE” will be flashing.
6. Press the DOWN or UP buttons to set the number of days in the cycle from 1 to 31. (For example: to water every 5 days set the day cycle to “5.”)
7. Return the dial to AUTO.

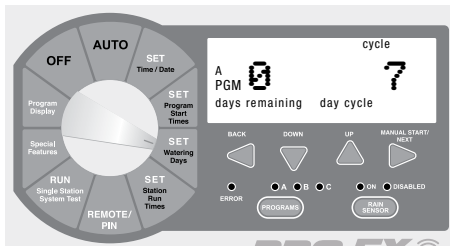

SET STATION RUN TIMES

Stations 1–28 can be set to run from one second up to six hours. The first hour settings are in one minute increments. The remaining five hours can be set in ten minute increments.

1. Use the PROGRAM SELECT BUTTON to select the program (A, B or C) you wish to assign a run time.
2. Turn the dial to SET STATION RUN TIMES. The display will show all available stations (module must be installed). The first available station number will be flashing.
3. Press the DOWN or UP buttons to set the number of seconds/minutes/hours you wish the station to operate (run time). For stations that don't require a run time set to “OFF.”
4. Press the NEXT button to advance to the next station number in sequence. Repeat steps 3 and 4 until you have set a run time for each desired station in the selected program.
5. Return the dial to AUTO.

NOTE: Station run times can be set to run in hours/minutes.

During station run time setting, if the next button is pressed to a station number that doesn't have an installed module, a message indicating “NO MOD” will appear in the display.

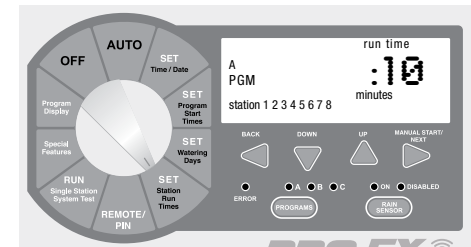

MANUAL PROGRAM OPERATION

When a full program operation is needed the user can manually start any of the three (A, B or C) programs.

1. Use the PROGRAM SELECT BUTTON to select the program (A, B or C) you wish to manually operate.
2. Turn the dial to AUTO or RUN PROGRAM.
3. Press MANUAL START / NEXT button to start the selected program.
4. The display will show "RUN," the station currently running and the remaining run time for that station. As each station completes its previously programmed run time the next station in sequence will begin watering.
5. Manual operation can be canceled anytime by turning the dial to OFF for 3 seconds.
6. Return the dial to AUTO.

NOTE: Pressing the BACK or NEXT buttons will manually advance to the next or previous station number.

Previously programmed run times can be increased or decreased during manual operation. Any run time changes during manual operation WILL NOT change the station's stored program run time.

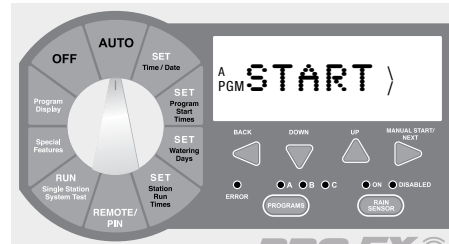
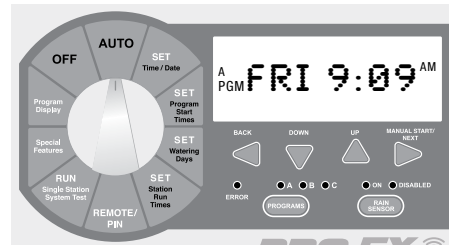

REMOTE PIN

The Pro EX 2.0 has an optional Handheld Remote (not included) for convenient controller operation eliminating back and forth trips to the controller.

NOTE: To use this feature the controller must be connected to AC power and the optional Remote RF Module must be installed.

For RF Module installation, Pin Code programming and operation please refer to the optional Pro EX 2.0 remote user manual.

RUNNING A SINGLE STATION MANUALLY

When only a single station operation is needed, the user can manually start a specific station.

1. Use the PROGRAM select button to select the program (A, B or C) that contains the station you wish to manually operate.
2. Turn the dial to RUN SINGLE STATION. The display will show selected program and the word "SINGLE." Press the NEXT button to enter single station operation.
3. Press the UP or DOWN buttons to select desired station.
4. Press the MANUAL START button to begin station operation.

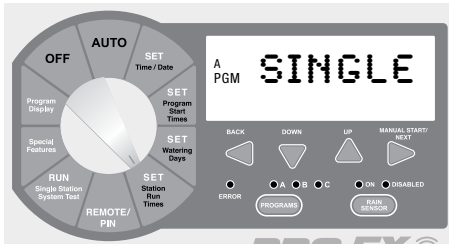

NOTE: Pressing the BACK or NEXT buttons will manually advance to the next or previous station number.

Previously programmed run times can be increased or decreased during manual operation. Any run time changes during manual operation WILL NOT change the station's stored program run time.

If the station has a zero run time (OFF) use the PROGRAM SELECT BUTTON to select a different program.

Stations with a zero run time (OFF) can not be manually activated. Only stations with a previously programmed run time can be manually started.

VALVE LOCATOR

Locating a valve in an irrigation system may be needed for maintenance or repair. Without the correct tools locating the valves can be timely.

The Pro EX 2.0 controllers locate feature helps the user find buried valves by pulsing the valves solenoid.

1. Turn the dial to RUN SINGLE STATION/SYSTEM TEST. The display will show selected program and "SINGLE." Press the UP or DOWN buttons until display shows "LOCATE."
2. Press the MANUAL START button to begin the locate feature. The display will now show the first available station.
3. Press the MANUAL START button to advance to the next available station.

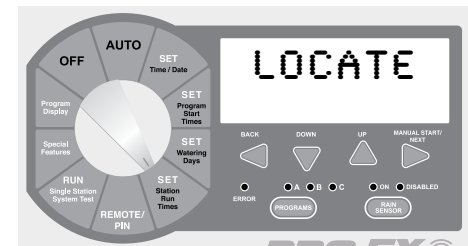

TEST ALL STATIONS

The Pro EX 2.0 allows the user a quick and simple method for checking all available stations by running a test program. This feature operates each station individually in numerical order starting with the lowest available station.

Station operation is preset for a two minute run time which the user can alter at anytime during the test.

1. Turn the dial to SYSTEM TEST. The display will show selected program and “SINGLE.” Press the UP or DOWN buttons until display shows “TEST.”
2. Press the MANUAL START button to begin the test feature. The display will now show “RUN” along with its remaining run time for the first available station.
3. To change the default test time press the UP or DOWN buttons. While the test program is running the display shows the station number currently operating, along with its remaining run time. The controller will run each station in numerical sequence.
4. Press the NEXT button to manually advance to the next available station.

NOTE: Changing the test run time can be done at anytime and for any station during the test. Any change to the test run time becomes the new default for all stations.

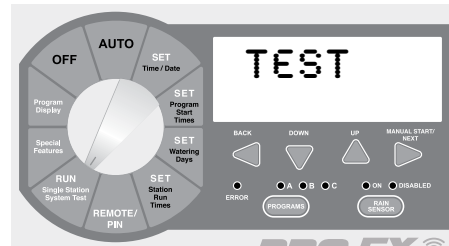

SPECIAL FEATURES

SEASONAL ADJUST

The seasonal adjust feature allows the user to increase or decrease station run times globally, for all stations, without re-programming each individual station. Run times can be reduced to as little as 10% or as high as 200%.

This feature is used to decrease or increase watering times during seasonal temperature changes. The seasonal adjust % is calculated on the programmed run time for each station. For example: if a station is programmed to run 10 minutes, and the seasonal adjust is adjusted downward 80%, the station will now run for 8 minutes. Conversely, if you set the adjustment upwards to 120%, the same station will now run for 12 minutes.

1. Turn the dial to SPECIAL FEATURES. Display will show “SEASONAL ADJUST % 100.”
2. Press UP or DOWN buttons to set the percentage in 10 degree increments.
3. Return the dial to AUTO.



STATION DELAY/OVERLAP

NOTE: This feature is not able to be set remotely via smartphone, tablet or browser.

The station delay / overlap feature allows the user to insert a global time delay or overlap between the end of any station's watering cycle & the beginning of the next station's watering cycle.

Station delay is used in systems that have slow closing valves or pump systems operating with a slow recovery time.

Station overlap is used to reduce hydraulic overload (water hammer).

1. Turn the dial to SPECIAL FEATURES. Display will show “SEASONAL ADJUST % 100.”
2. Press NEXT button to enter the delay/overlap feature. The display will show “DELAY 0:00.”
3. Press the UP button to add a delay time. Delay times can be set from 1 second up to 9 hours.
4. Press DOWN button to add an overlap time. Overlap times can be set from 1 to 9 seconds.
5. Return the dial to AUTO.

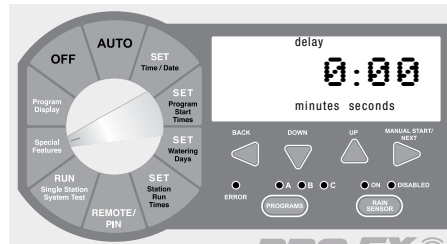

PUMP ON / OFF

NOTE: This feature is not able to be set remotely via smartphone, tablet or browser.

The PUMP ON/OFF feature allows the user to enable or disable the MV/PS terminal for each individual station.

The ON/OFF feature is used in irrigation systems where it is desirable for a pump to operate or not operate for a specific station(s).

1. Turn dial to SPECIAL FEATURES. Display will show “SEASONAL ADJUST % 100.”
2. Press NEXT button until “PUMP” is displayed.
3. Press the BACK and NEXT buttons simultaneously to enter the PUMP ON/OFF feature. The display will show “PUMP ON” and all stations.
4. Press the BACK or NEXT buttons to select desired station.
5. Press UP or DOWN buttons to activate (ON) or deactivate (OFF) the station.
6. Return the dial to AUTO.

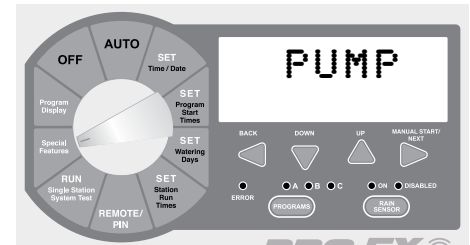

SENSOR

The SENSOR on/off feature allows the user to enable or disable the SENSOR terminals for each individual station.

The on/off feature is used in irrigation systems where it is desirable for a Rain Sensor to operate or not operate for a specific station(s).

1. Turn the dial to SPECIAL FEATURES. Display will show “SEASONAL ADJUST % 100.”
2. Press NEXT button until “SENSOR” is displayed.
3. Press BACK and NEXT button simultaneously to enter the sensor ON / OFF feature. The display will show “ACTIVE” and all stations.
4. Press the BACK or NEXT buttons to select desired station.
5. Press the UP or DOWN buttons to activate (ON) or bypass (OFF) the station.
6. Return the dial to AUTO.

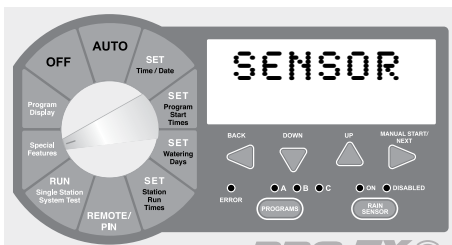

OPEN CIRCUIT DETECTION

The open circuit detection feature prevents pump and station operation when the controller detects an open circuit.

The open circuit detection feature can only be enabled (ON) or disabled (OFF) globally for all stations.

1. Turn the dial to SPECIAL FEATURES. Display will show “SEASONAL ADJUST % 100.”
2. Press the NEXT button until “OPENOFF” is displayed.
3. Press the “UP” or “DOWN” buttons to activate or deactivate the open circuit detection feature.
4. Return the dial to AUTO.

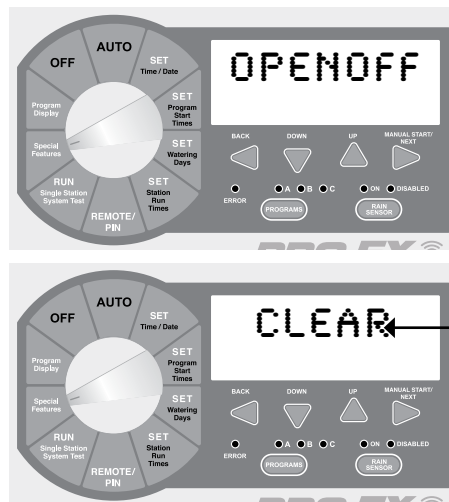

CLEAR

NOTE: If the controller is connected to the INTERNET, and the program settings have been saved, you can clear the controller and then restore the previous program settings in order to automatically connect the controller back to the INTERNET and continue to program your controller from your smartphone or tablet.

If the controller is reset to factory default AND the program WAS NOT SAVED as well as connected to the INTERNET via WiFi Hub, the connection must be re-established by reconnecting the controller to the hub and reprogramming. See quick start guide.

The CLEAR feature allows the user to erase all current programming and restore the original factory default program (all available stations, everyday for ten minutes).

1. Turn the dial to SPECIAL FEATURES. The display will show “SEASONAL ADJUST % 100.”
2. Press the NEXT button until “CLEAR” is displayed.
3. To enter the CLEAR feature press the UP or DOWN button and the display should now show “CLEAR*.”
4. Press the NEXT button to clear the current program. The display will briefly show “CLEARED” before automatically advancing to the next available feature.
5. Return the dial to AUTO.

SPECIAL FEATURES

SAVE

The SAVE feature allows the user to save all current programming. This allows the user to quickly and easily restore any saved program(s) should they be changed.

1. Turn the dial to SPECIAL FEATURES. Display will show "SEASONAL ADJUST % 100."
2. Press the NEXT button until "SAVE" is displayed.
3. To enter the SAVE feature press the UP or DOWN button and the display should now show "SAVE*."
4. Press the NEXT button to save the current program(s). The display will briefly show "SAVED" before automatically advancing to the next available feature.
5. Return the dial to AUTO.

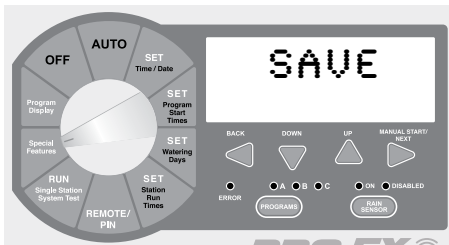

RESTORE

The "RESTORE" feature allows the user to restore any previously saved programs.

1. Turn the dial to SPECIAL FEATURES. Display will show "SEASONAL ADJUST % 100."
2. Press the NEXT button until "RESTORE" is displayed.
3. To enter the RESTORE feature press the UP or DOWN button and the display should now show "RESTORE."
4. Press the NEXT button to restore any previously SAVED program(s). Display will briefly show "RESTORE" before automatically advancing to the next available feature.
5. Return the dial to AUTO.

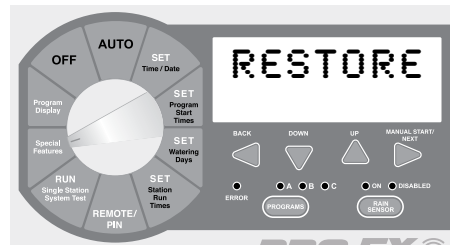

DISPLAY CONTRAST

The "CONTRAST" feature allows the user to adjust the display for best viewing.

1. Turn the dial to SPECIAL FEATURES. The display will show "SEASONAL ADJUST % 100."
2. Press the NEXT button until "CONTR 0" is displayed.
3. Press the UP or DOWN buttons to increase (+9) or decrease (-9) display contrast.
4. Return the dial to AUTO.

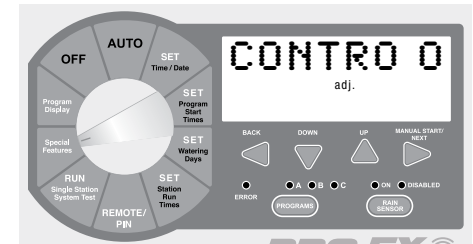

PERMANENT DAY OFF

Permanent days off programmed through special features will not display on program features OR in the smartphone/tablet interface

Some users or water conservation programs may desire that a specific day(s) of the week be prohibited from watering.

The DAY OFF feature allows the user to select a day or days of the week where the system will not operate regardless of SET WATERING DAYS program.

1. Turn the dial to SPECIAL FEATURES. Display will show "SEASONAL ADJUST % 100."
2. Press the NEXT button until "DAY OFF" is displayed and a flashing "MON" in the upper left corner of the LCD.

3. Press the UP or DOWN buttons to enable (turn on) the day off feature. The display will now show a solid (non-flashing) "MON."
4. Press the NEXT button to advance to the next day of the week.
5. Repeat steps 3 and 4 until all non-watering days have been selected.
6. Return the dial to AUTO.

NOTE: All days visible at the top of the display will become non-watering days regardless of programming.

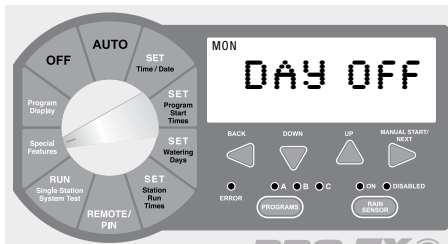

SPECIAL FEATURES

SET FLOW METER

Using a flow sensor in conjunction with your controller allows you to monitor, control, and react to real-time water flow conditions. Using this feature allows you to set Hi/Lo flow limits for individual stations or globally by program.

1. Turn the dial to SPECIAL FEATURES. Display will show "SEASONAL ADJUST % 100".

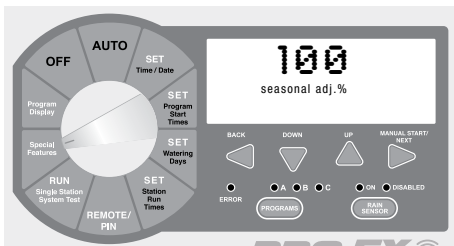

2. To set up your flow meter type, push NEXT or BACK until "SET MTR" is displayed.

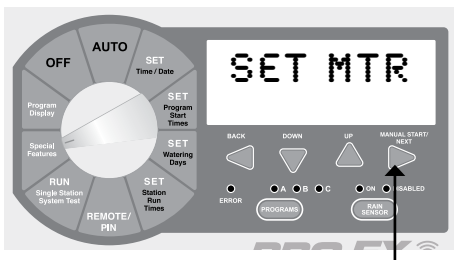

3. Then press the NEXT button until FLOWMTR is displayed. Push NEXT to select.

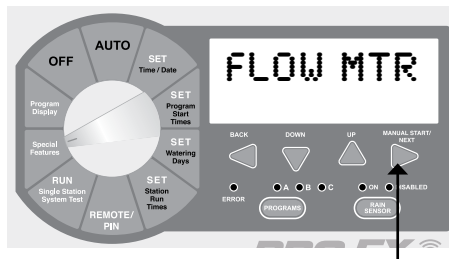

FLOW OFF is the default setting. Use the UP or DOWN arrows to toggle this on or off. You can also turn your flow sensor off temporarily, without losing any of the limits you entered.

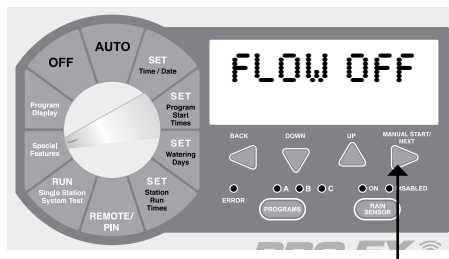

4. Push NEXT to go to flow meter type selection

5. After "SELSIZE" is displayed, push NEXT to select and proceed to choose the flow meter type and pipe size you have.



Choose one of the following selections using the UP or DOWN buttons to toggle through the screens:

- 735 1:0 (Model FS73510, 1" pipe)
- 228 1:5 (Model FS22815, 1.5" pipe)
- 228 2:0 (Model FS22820, 2" pipe)
- 228 3:0 (Model FS22830, 3" pipe)
- 228 4:0 (Model FS22840, 4" pipe)

The first three numbers identify the model you are using. The next set of numbers identify the size of your in line pipe. Once you have located your specific model and pipe size, simply stop toggling. Your flow sensor setup is now complete.

You can now set the optional HI/LO flow limits if you choose.

SET OPTIONAL HI/LO FLOW LIMITS

Using the HI/LO flow limits feature allows you to fine tune your flow sensing. Setting these limits helps in diagnosing or pinpointing where you may have a water management issue, a line break, a broken head or even a clogged line, for example. You can either keep them very general and set the limits by program or be very specific and set the limits by individual zone.

To Set the Flow Sensor HI/LO Flow Limits:

1. Turn the dial to SPECIAL FEATURES. Display will show "SEASONAL ADJUST % 100."



2. Press the NEXT or BACK button until SET MTR is displayed.

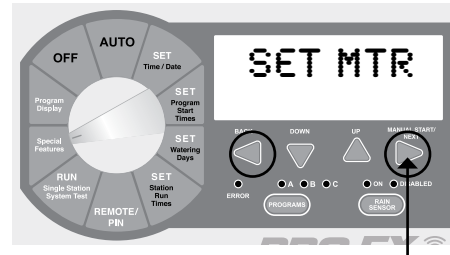

3. Push the BACK and NEXT buttons at the same time to get to the HI/LO limit settings.

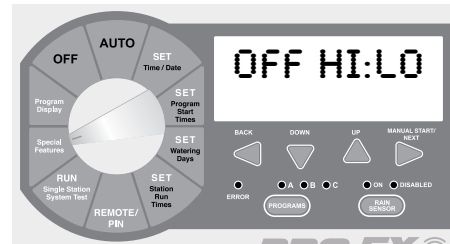

The default is set to OFF but you can toggle between OFF and ON using the UP or DOWN button. Press NEXT.

This default is set to "BY PROGRAM", but you can toggle with the UP or DOWN button to switch to BY ZONE.

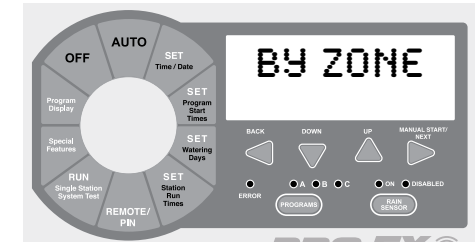
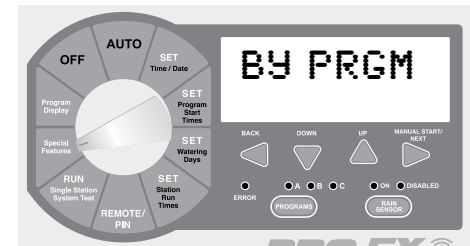

4. Push NEXT on the setting you wish to use.

SPECIAL FEATURES

SETTING BY PROGRAM

1. Push NEXT to select BY PROGRAM.

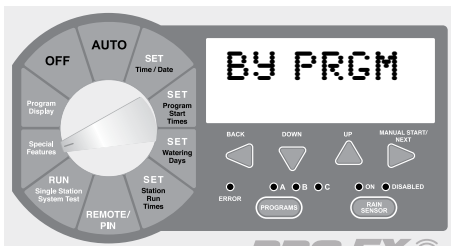

The display will show what program you are currently in as well as the setting.

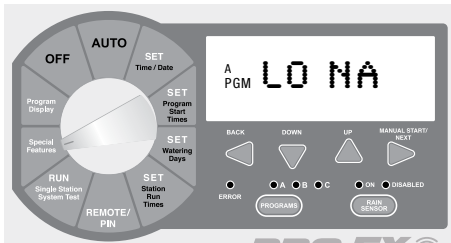

The example here shows that the flow sensor is in program "A" and it is ready to set the "LO" limit. The default is set to NA.

2. Push the UP button to start the Low setting at 1 Gallon Per Minute (GPM) or alternatively push the DOWN button to start at 500 GPM. Continue to use UP or DOWN until you reach your desired LO flow limit setting.

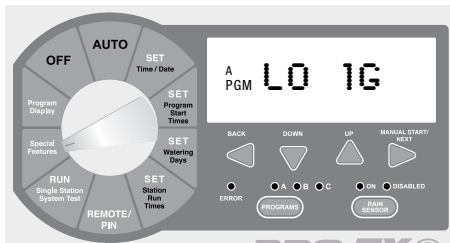

3. Push NEXT to repeat the process for the Low Flow settings for programs B and C. Afterwards, push NEXT until you reach the HI flow limit settings or switch the dial position to AUTO if complete.

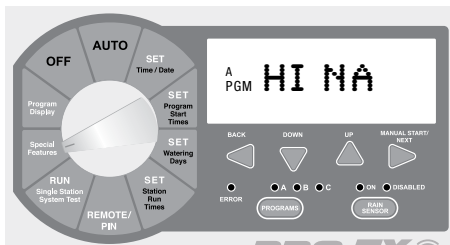

The HI flow default is set to NA. Push the UP button to start the HI setting at 1 Gallon Per Minute (GPM) above your LO setting or push the DOWN button to start at 500 GPM.

4. Continue to use UP or DOWN buttons until you reach your desired HI flow limit setting. The example here shows that the flow sensor is in the "A" program and the high flow limit is set to 125 gallons per minute.

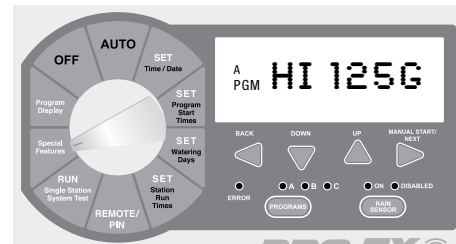

5. Push NEXT to go to the Hi flow Setting for program B, or switch the dial position to AUTO if complete.

SETTING BY ZONE

1. Push NEXT to select BY ZONE.

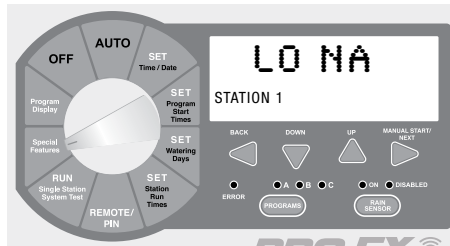

The display will show what ZONE (or STATION) you are currently on and the setting.

The example here shows that the flow sensor is on STATION 1 and the low (LO) limit is ready to be set. The default is set to NA.

2. Push the UP button to start the LO setting at 1 Gallon Per Minute (GPM) or push the DOWN button to start at 500 GPM. Continue to use the UP or DOWN buttons until you reach your desired low flow limit setting for that zone. The example here shows that the station 1 low limit is set to 1 gallon per minute.

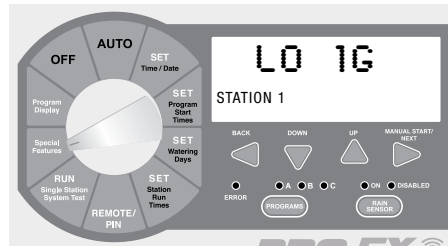

3. Push NEXT to set the High flow limit for that zone.

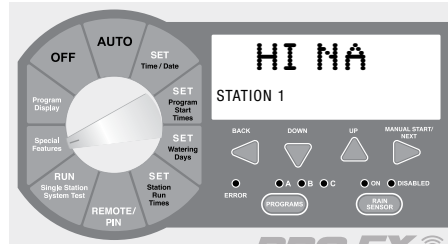

4. The default is set to NA. Push the UP button to start the High (HI) setting at 1 Gallon Per Minute (GPM) above your low setting or push the DOWN button to start at 500 GPM.

5. Continue to use the UP or DOWN buttons until you reach your desired high flow limit setting. The example here shows that the station 1 high limit is set to 125 gallons per minute.

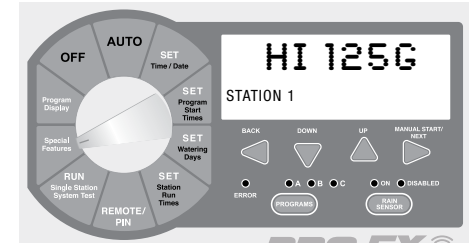

6. Push NEXT to set the limits for the next station. Repeat until complete.

SPECIAL FEATURES

FLOW HISTORY

The flow history function allows the user to view one week's worth of stored flow data. It will show how much water was used on each station for each day of the week. If there are several run times in one day, it will total them for the day.

To View Your Flow Sensing History:

1. Turn the dial to SPECIAL FEATURES. Display will show "SEASONAL ADJUST % 100.



2. Press the NEXT or BACK button until FLOHIST is displayed "LO" limit. The default is set to NA.

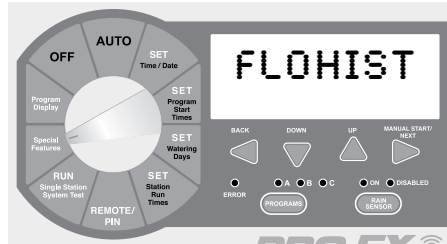

3. To See the Flow History of your system, push NEXT.

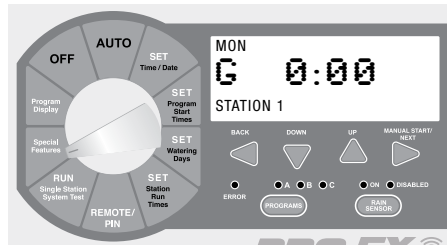

The default screen shows the first available Zone with the first available Day of the week.

4. Use the UP or DOWN buttons to toggle through the days of the week.
5. Use the BACK and NEXT arrows to toggle through the available Zones.

This example shows you that last Thursday, Zone 8 used 101 Gallons of water.

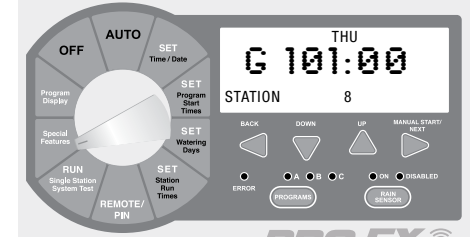

The controller will keep 1 full week of data.

SET FLOW UNITS

This feature allows you to switch back and forth between Gallons Per Minute (shown as G) or Liters Per Minute. (shown as L).

To Set the Flow Data Units that the Controller will Display:

1. Turn the dial to SPECIAL FEATURES. Display will show "SEASONAL ADJUST % 100.

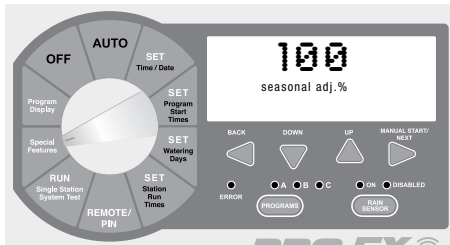

2. Press the NEXT or BACK button until UNIT G is displayed. The default setting is for Gallons Per Minute (G).

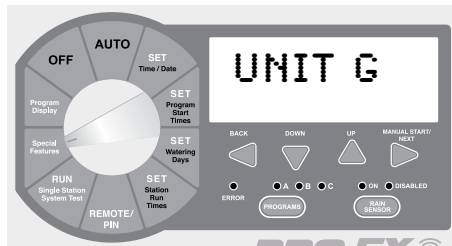

3. Use the UP and DOWN buttons to toggle back and forth to Liters Per Minute (L).

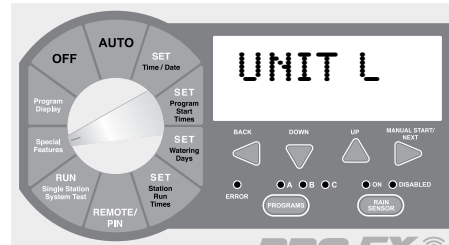

4. Choose BACK or NEXT or turn the DIAL to complete your selection.

SPECIAL FEATURES

SEE LIVE FLOW DATA

This feature allows the user to see live flow data in a few different ways. You can view the data under Special Features while a Program is running or during Manual operation. This gives you a real time look at how your system is performing as well as an idea of the parameters to use for setting HI/LO flow limits.

To See Live Flow Data:

1. Turn the dial to SPECIAL FEATURES. Display show "SEASONAL ADJUST % 100.



2. Press the NEXT or BACK button until GPM N:A is displayed. This screen will be active but probably not accurate until you have set up the flow meter type (see page 15). After you set up your meter, this will display the actual flow data in real time.

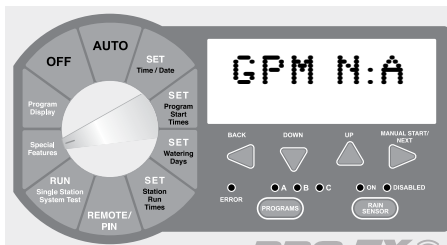

Alternate Ways to See Real Time Data:

1. You can see real time flow data during a program by simply pressing the BACK and NEXT buttons at the same time.

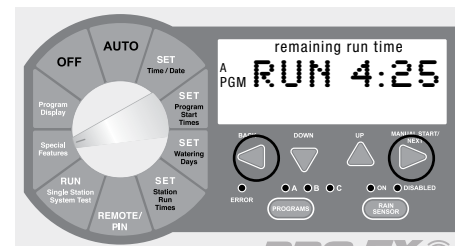

2. Press the BACK and NEXT buttons at the same time again to go back to the main screen. This can also be done while performing a Manual Run Time.



POSSIBLE ALARM DISPLAYS

The following are possible alarms that could be displayed in conjunction when using a flow meter with this controller.

FLOW LO

This is the alarm that will show if your system is registering a flow that is set lower than the LO limit you prescribed.

If you set your limit BY PROGRAM, then the corresponding program letter will be flashing.

If you set your limit BY ZONE, then the station that was running when the low flow limit was reached will be flashing.

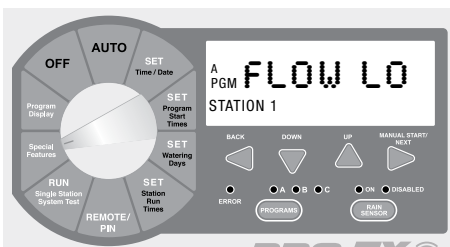

FLOW HI

This is the alarm that will show if your system is registering a flow that is set higher than the HI limit you prescribed.

If you set your limit BY PROGRAM, then the corresponding program letter will be flashing.

If you set your limit BY ZONE, then the station that was running when the low flow limit was reached will be flashing.

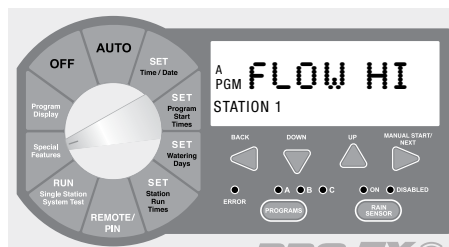

H2OLEAK

The H2OLEAK is an alarm that is triggered when flow is detected on the system and there is no active program running. This alarm will only be triggered from 4 minutes after any assigned program until 4 minutes before the next program.

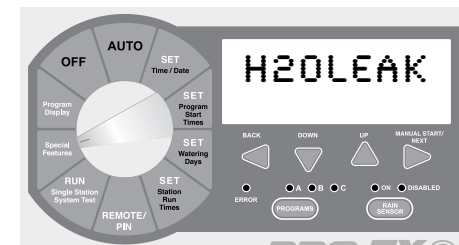

NO FLOW

The NO FLOW is an alarm that is triggered when there is no flow detected on the system and there is an active program running.



NOTE: The system will run the zone for 90 seconds to make sure the flow is accurate before tripping the alarm. Once the alarm is tripped, the system will move on to the next zone in the program.

PROGRAM DISPLAY

The Pro EX 2.0 program display feature provides a complete visual overview of any program contents.

From this one screen the user can see all programmed Watering Days, the number of Watering Start Times and Stations with a run time per each individual program.

1. Turn the Dial to PROGRAM DISPLAY.
2. Use the Program Switch to select the program (A, B or C) you wish to review.
3. If more than one start time has been set (maximum of four), they will appear next to "START TIME" on the display.
4. Press the NEXT button to view any additional start times.
5. Return the dial to AUTO. Resetting the controller processor should not affect the WiFi Hub connection.

RESETTING THE CONTROLLER

The reset button is used to reset the controller. All programming information will remain intact.

1. Open the front panel by grasping the finger-hold on the top right side of the front panel. Swing the panel open to the left.
2. Locate the RESET button on the back of the panel. Using the tip of a pencil or other pointed object press and release the RESET button. Display will be blank while the RESET button is depressed.

3. Close the panel by swinging it back to the right and press until it locks into the closed position.
4. Return the dial to AUTO. Display will show the default day of the week and time.

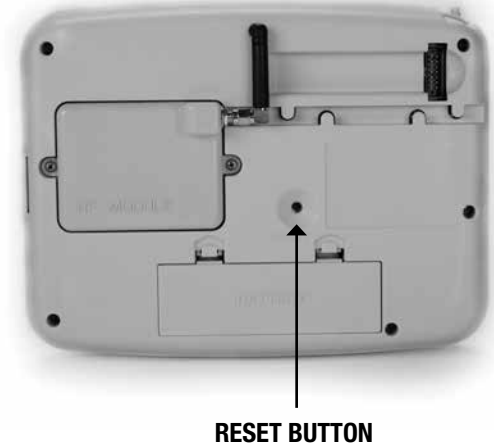

INSTALLATION

The Pro EX 2.0 controller can be installed either indoors or outdoors and must be done in compliance with local electrical codes.

For the best viewing and ease of programming we recommend installation at eye level.

The mounting location should have access to 115VAC or 220VAC electrical power and allow enough bottom clearance for the installation of conduit or a “junction” box if required.

Installation should be done at least 15 feet away from a pump start relay or any high draw motors, such as air conditioners and refrigerators.

For ease of installation the enclosure door and main panel can be removed. 12 inches of horizontal clearance to the left is necessary to fully open the hinged door.

DOOR REMOVAL

1. Making sure the door is unlocked, open the enclosure door and swing it to the left until fully open.
2. Using both hands grasp both the top and bottom portions of the door at the hinge location.
3. Gently pull either the top or bottom portion of the door forward until the door releases.

MAIN PANEL REMOVAL

1. Open the front panel by grasping the finger hold on the top right side of the front panel. Swing the panel open to the left.
2. Disconnect the ribbon cable from the rear of the main panel by gently pulling the ribbon connector straight out of the socket.
3. Using both hands grasp both the top and bottom portions of the main panel at the hinge location.
4. Gently push the main panel upwards until the hinge pin is free of the enclosure socket.

MOUNTING THE CONTROLLER

The Pro EX 2.0 controller has a single keyhole slot on the top / back of the controller. Three circular mounting holes are located at the bottom / back of the controller. One of the three mounting holes is located inside the 115VAC or 220VAC connection box.

Use a pencil to mark the eye level position on the mounting wall. Or, use the template provided for easy installation.

Drive an appropriate fastening device for the type of wall material into the mark for the keyhole.

Hang the controller on the keyhole slot making sure the fastener is secured on the narrow neck area of the keyhole slot.

Making sure the controller is level, drive an appropriate fastener(s) in the lower circular hole(s).

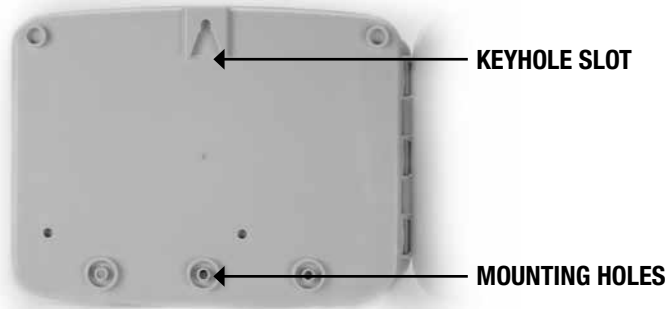

KEYHOLE SLOT

MOUNTING HOLES

The Pro EX 2.0 controller has four “knockout” plugs available for routing valve, pump start and sensor wires. All four are located on the bottom of the cabinet and sized to 1/2”, 3/4” or 1” PVC male adapters.

In the combination “knockout” plugs, tap a screwdriver in the groove around the knockout in several places to remove the smaller knockout.

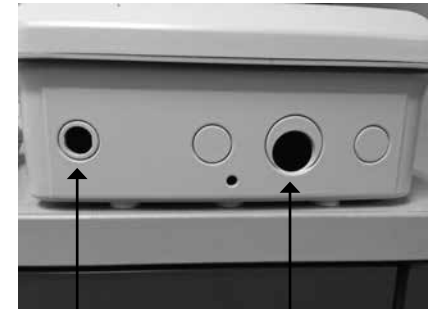

KNOCKOUT PLUGS

INSTALLING A 4 STATION MODULE

The Pro EX 2.0 controller is supplied with a factory installed four station module and can be expanded up to 28 stations by use of additional expansion modules.

1. Connect the module ribbon cable to the main enclosure (Fig. 1) by gently pushing the ribbon connector straight onto the connector post. Module terminals should be facing towards the center of the enclosure.
2. Slide module under the tab (Fig. 2) labeled with the station numbers.
3. Pushing module into position (Fig. 3), use the pre-installed screw to secure the module fully.

NOTE: DO NOT over tighten the screw. The screw should only be turned enough to hold the module snug to the enclosure.

Fig. 1



Fig. 2



Fig. 3



INSTALLING A 14 STATION MODULE

The Pro EX 2.0 controller is supplied with a factory installed four station module and can be expanded up to 28 stations by use of optional 14 station expansion modules.

1. Connect the module ribbon cable to the main enclosure (Fig. 4) by gently pushing the ribbon connector straight onto the connector post. Module terminals should be facing towards the center of the enclosure.
2. Slide module under the tab (Fig. 5) labeled with the station numbers.
3. Pushing module into position (Fig. 6), use the pre-installed screw to secure the module fully.

NOTE: DO NOT overtighten the screw. The screw should only be turned enough to hold the module snug to the enclosure.

Fig. 4



Fig. 5

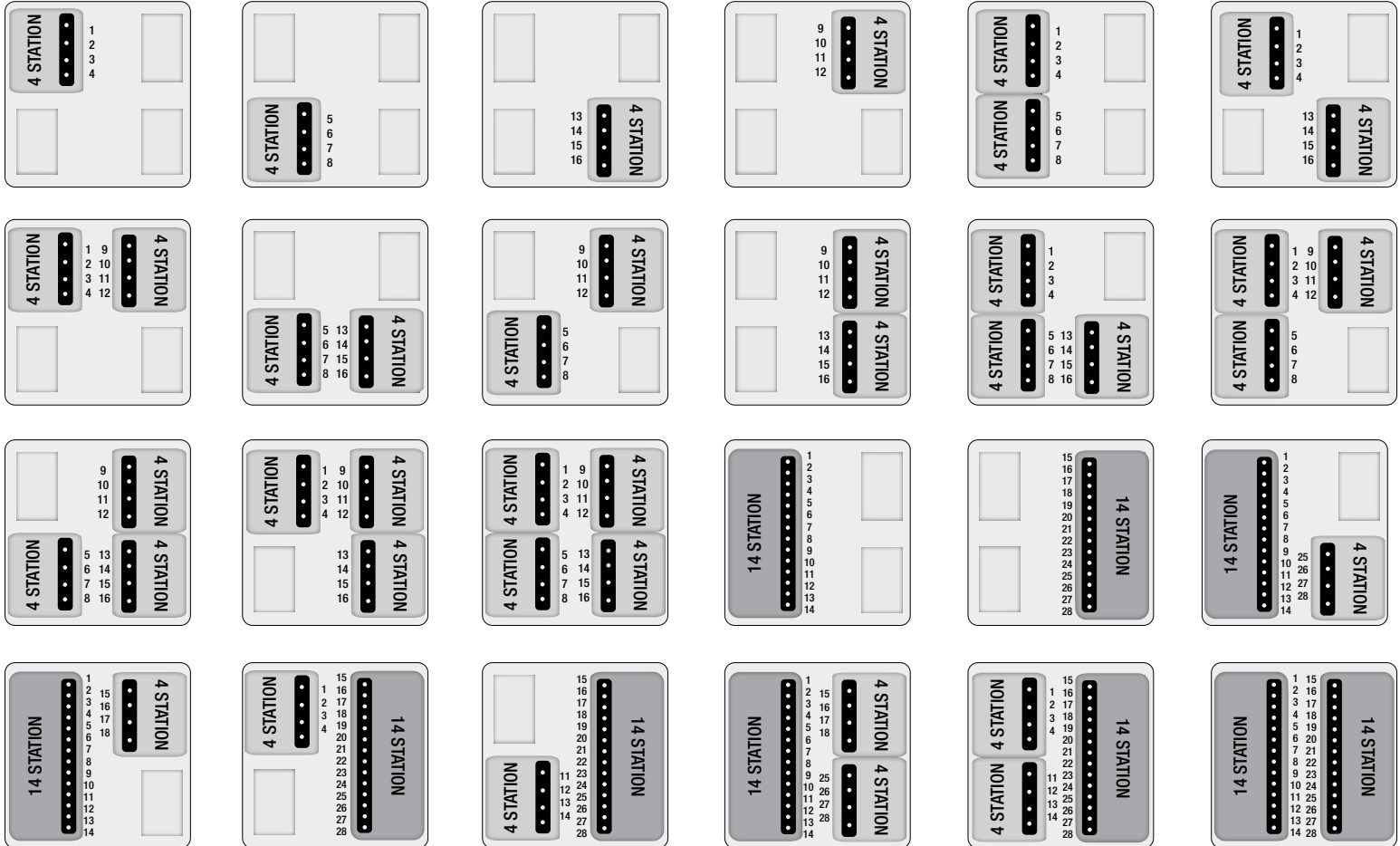

Fig. 6



MODULE LAYOUT COMBINATIONS

Shown below are the possible module layouts and what the new station numbers would be with those combinations of modules.



INSTALLING A 14 STATION MODULE

To install a second 14 station module, simply follow the previous steps but use the lower connector post on the right side of the controller.



CONNECTING VALVE WIRES

1. Connect each valve with its individual power wire to one of the numbered screw terminals. Station numbers are engraved in the base unit with the following numbering: 1, 2, 3, 4, 5, 6, 7, 8, 9, 10, 11, 12, 13, 14, 15 and 16.
2. Connect the common field wire from all valves to the COM terminal screw located at the lower right corner between the Valve Test and Pump Start/Master Valve terminal screws.
3. Only use code approved wiring for underground installation.

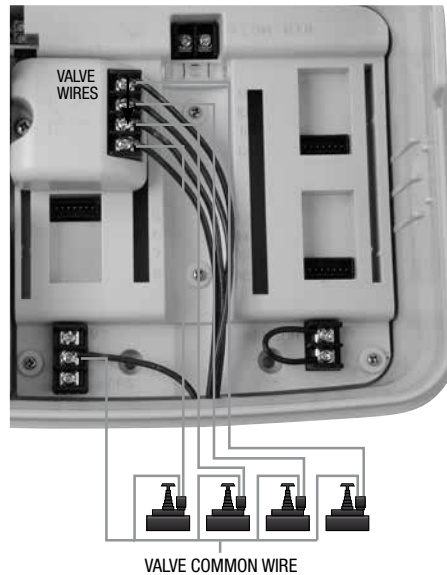

CONNECTING THE FLOW SENSOR

1. Connect the black wire to the negative (-) terminal. Connect the red wire to the positive (+) terminal.



PUMP START RELAY / MASTER VALVE WIRING

This section is only for systems that require a pump start relay or master valve. The controller does not provide main power for a pump.

Master Valve or Pump Start Relay wiring terminals “COM” & “MV/PS” are located at the lower right corner of the cabinet.

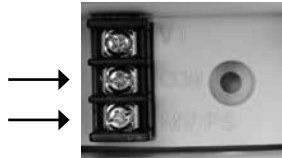

NOTE: JUMPERS FOR UNUSED STATIONS

To prevent pump or system damage when using a pump start relay, use a jumper to connect all unused stations to the last station with a run time.

Unused station(s) without a jumper could cause pump or system damage should the unused station be turned on. Pump operation with no flow (dead-head), could cause over-pressurization of the system or the pump to overheat.

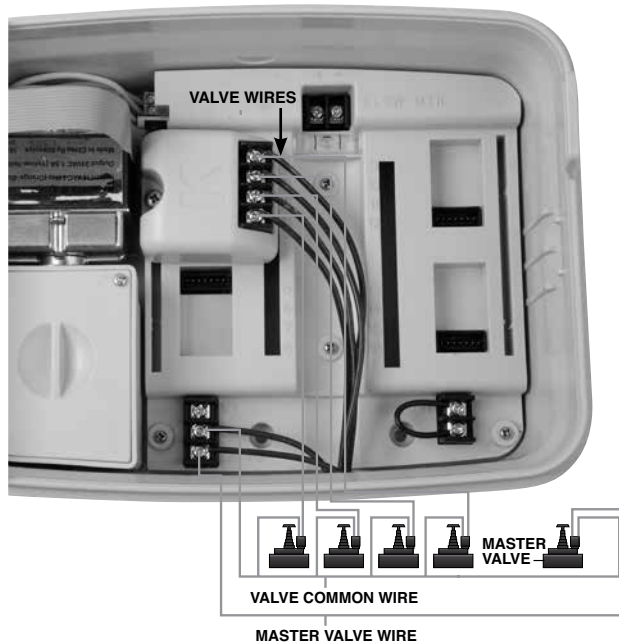

RAIN SENSOR INSTALLATION

All electrical connections and wiring must be made according to local building codes.

1. Open the cabinet door.
2. Open the front panel by grasping the finger-hold on the top right side of the front panel. Swing the panel open to the left.
3. Connect the two rain sensor wires to the two terminals marked SENSOR located in the lower right corner of the cabinet.

NOTE: If a rain sensor has not been installed in the Pro EX 2.0 controller, the pre-installed jumper wire must remain installed on the SENSOR terminals.

For wireless rain sensors needing an additional power source, use the VT terminal for 24VAC and use the COM terminal for the common. Both are located in the lower left corner of the cabinet.

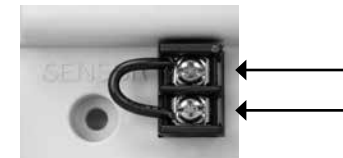

REMOTE PROGRAMMING

The Pro EX 2.0 controller allows the user to program the controller with the main panel disconnected from the cabinet. The user must first install the four factory supplied AAA batteries in the back panel to access this feature.

1. Open the cabinet door.
2. Open the main panel by grasping the finger–hold located on the top right side of the cabinet.
3. Locate the battery compartment on the rear of the main panel. To open, press down on the two locking tabs and pull the cover off.
4. If you are replacing the batteries, pull the old batteries out of the compartment. Install the new batteries making sure to follow positive (+) and negative (-) polarity markings.
5. To close, replace battery cover and press the two locking tabs until they snap back into their locked position.

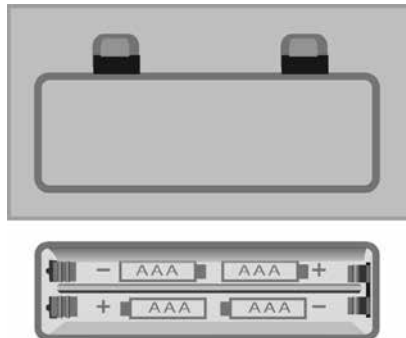

POWERING THE CONTROLLER

It is recommended that a licensed electrician perform the following power installation.

All electrical connections and wiring must be made according to local building codes. Make sure all electrical power is turned off before any wire connections are attempted.

For ease of installation the enclosure door and main panel can be removed. Please refer to the installation instructions located on page 20 for door and main panel removal.

FOR OUTDOOR CONTROLLER ONLY:

The knockout located on bottom left side of the cabinet should be used to bring AC power wires and conduit into the power junction box.

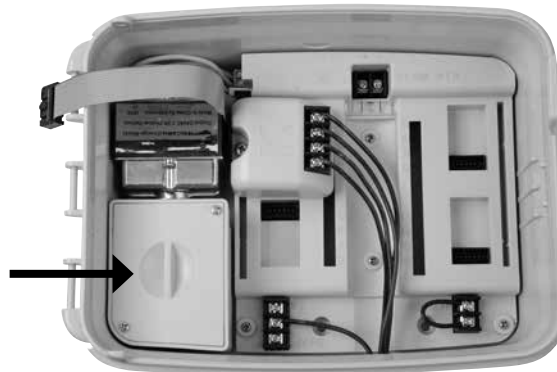

The Pro EX 2.0 controller is powered with either 115VAC or 220VAC which must be noted when ordering the unit.

Connect the AC wires to the transformer wires located inside the power junction box with wire nuts or other locally approved connectors.

⚠ WARNING: Risk of explosion. Potential risk if battery is replaced with an incorrect type. Battery must be removed and disposed of properly.

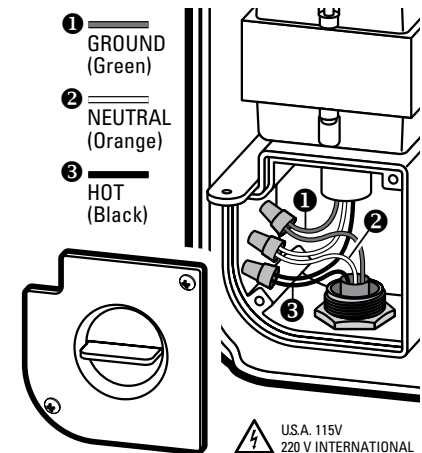

⚠ U.S.A. 115V
220 V INTERNATIONAL

SPECIFICATIONS

OPERATING SPECIFICATIONS

FOR INDOOR CONTROLLER ONLY:

The Pro EX 2.0 controller is powered with either 115VAC or 220VAC which must be noted when ordering the unit.

Installation is easy. Simply plug the connector from the controller with the connector on the end of the plug pack.

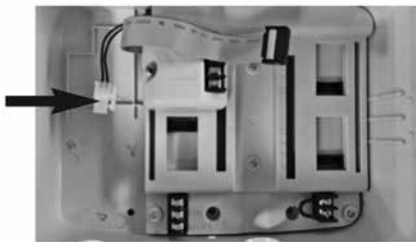

- Station Run Times:
1 second to 6 hours on programs A, B and C.
- Start Times: 4 per program (12 maximum per day).
- Watering Schedule:
7-day calendar (any day of the week), odd or even calendar day, interval watering up to 31 days.
- Operating Temperature:
0-140° F (18-60° C)

WIFI HUB SPECIFICATIONS:

- Ultra low-power signal
- Supported networks 802.11 abgn WPA, WPA2, WEP 64 bit
- FCC Certified
- Power Source:
100 - 240 AC 50/60 HZ UL Listed
- Non-Removable Antenna
- 250 ft. Line-of-site to Irrigation Controller via Radio Frequency
- 50 ft. Line-of-site to wireless router

ELECTRICAL SPECIFICATIONS

- Transformer Input:
115VAC, 60Hz or 220 VAC, 50/60Hz
- Transformer Output:
Outdoor Unit: 24VAC, 1.5 amp
Indoor Unit: 24VAC, 1 amp
- Maximum Output:
Outdoor Unit: 24VAC, 1.25 amp
Indoor Unit: 24VAC, 0.75 amp (includes Master Valve/Pump Start)
- Battery:
4 each AAA alkaline batteries (included) used for remote programming.
- For PERMANENTLY CONNECTED EQUIPMENT, a readily accessible disconnect device shall be incorporated external to the equipment.

DIMENSIONS

- Height: 7 3/4" / Width: 10" / Depth: 5"

DEFAULT SETTINGS

The Pro EX 2.0 controller has non-volatile memory that retains all programming data even during power outages and without the need for any battery back-up. Batteries are used for time and calendar accuracy and remote programming when the main panel has been removed from the cabinet.

TROUBLESHOOTING

SYMPTOM	POSSIBLE CAUSE	CORRECTION
PROGRAM DOES NOT COME ON AUTOMATICALLY	Dial set to the OFF position	Set dial to AUTO
	No Start Time	Turn the dial to PROGRAM DISPLAY and check program for start time(s). If missing turn dial to SET PROGRAM START TIMES and enter a start time(s) if needed (page 5)
	Permanent Day Off Feature is Active	Change permanent day programming if needed (page 14)
	No Primary AC Power	Restore primary AC power
	Today may not be a Scheduled Watering Day	Turn the dial to PROGRAM DISPLAY and check program Watering Day(s). If missing turn the dial to SET WATERING DAYS and enter watering day(s) if needed (page 6)
Active or Faulty Rain Sensor	Check LCD Display for BYPASSED or SENSOR. Set Rain Sensor Switch to the Bypassed position	
DISPLAY SHOWS A STATION IN OPERATION BUT NO WATERING OCCURS	No Primary AC Power	Restore primary AC power
	An Open Circuit in the Valve Solenoid or Wiring has disabled the station (Open Circuit Feature has been disabled – page 12)	Locate and repair Turning ON the Open Circuit Feature will prevent station operation when the valve solenoid or wiring has disabled the station (page 12)
	Rain Sensor is Active and preventing watering	If a recent rain event has occurred then no action is required. Place Rain Sensor Switch in the BY PASSED position to resume operation. If watering does not resume the Rain Sensor is not operating properly
	Sensor Jumper is missing	Replace Jumper

SYMPTOM	POSSIBLE CAUSE	CORRECTION
STATION(S) DOES NOT COME ON	No Station Run Time has been set	Turn the Dial to SET STATION RUN TIMES and check program station for run time
	A SHORT or OPEN circuit has disabled station operation	Locate and repair SHORT/ OPEN circuit. Error Tone, LED and Display will flash showing affected station(s). To temporarily clear the alarm, turn Dial to OFF position briefly and return Dial to AUTO. Controller will auto reset after repair has been performed
DISPLAY IS PARTIALLY OR COMPLETELY BLANK	Loss of primary AC power	Check for properly installed electrical installation Check for tripped electrical Breakers or fuses
	An electrical surge or strike has damaged the electronics	Perform a controller RESET. If no permanent damage occurred the controller will accept programming commands and function normally
STATION(S) REPEAT OPERATION	More than one (1) start time has been programmed	Turn the dial to PROGRAM DISPLAY and check program(s) for additional start time(s). If unwanted start times are present turn dial to SET PROGRAM START TIMES and remove (page 5)
	The programs could be stacked	Programs stack when another program start time occurs while another program is still running. Check all programs (A, B and C) and start times (4 per each program)

QUICK REFERENCE GUIDE

Need more assistance? Misplaced your owner's manual? Visit us at www.krain.com, go to Professional Products; Controllers, for a complete manual, or call 1-800-735-7246 for technical support.

PROGRAMMING OVERVIEW / Descripción de Programación



Use the dial to select programming functions
Utilice el dial para seleccionar funciones de programación

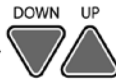

Change the current value in the LCD display
Cambia el valor actual en la pantalla LCD



Moves to previous or next value in the display
Cambia al valor siguiente en la pantalla

- 1 Set time and date (ex: 9:00 am / 1 Jan 12)**
Configurar la hora y la Fecha (Ejemplo: 9:00 am / 1 Jan 12)

- 2 Set program start times (ex: 9:00 am)**
Configurar la hora de programa (Ejemplo: 9:00 am)

- 3 Set watering days (ex: Monday, Wednesday & Friday)** Configurar riego por días de la semana (Ejemplo: Lunes, Miércoles y Viernes)

- 4 Set station run times** Configurar Tiempo de riego para cada estación.

Ex: Station 1 is set for 18 minutes, Station 2 is set for 25 minutes, Station 3 is set for 20 minutes and Station 4 is set for 30 minutes.
Ejemplo: estación 1 ajustada a 18 minutos, estación 2 ajustada a 25 minutos, estación 3 ajustada a 20 minutos y la estación 4 ajustada a 30 minutos



MANUAL OPERATION / Operación Manual

SPARE WATERING PLANNER

WATERING SCHEDULE	PROGRAM A	PROGRAM B	PROGRAM C
CUSTOM			
ODD/EVEN			
CYCLIC			

WATERING START TIMES

STATION	STATION LOCATION	STATION RUN TIMES
1		
2		
3		
4		
5		
6		
7		
8		
9		
10		
11		
12		
13		
14		

WATERING SCHEDULE	PROGRAM A	PROGRAM B	PROGRAM C
CUSTOM			
ODD/EVEN			
CYCLIC			

WATERING START TIMES

STATION	STATION LOCATION	STATION RUN TIMES
15		
16		
17		
18		
29		
20		
21		
22		
23		
24		
25		
26		
27		
28		

WARRANTY

The manufacturer guarantees to the original purchaser that any product supplied by the manufacturer will be free from defects in material and workmanship for a period of two years from the date of purchase. Any product found to have defects in material or workmanship within the warranty period shall be repaired or replaced by the manufacturer.

The manufacturer does not guarantee the use for a particular purpose of its products and does not make any guarantee, expressed or implied, other than the warranty contained herein. The manufacturer shall not be liable for any loss from use of the product or incidental or consequential damages to other parts of any installation of which this product is part.

The warranty shall not apply to any equipment which is found to have been improperly installed, set up or used in any way not in accordance with the instructions supplied with this equipment, or to have been modified, repaired or altered in any way without the expressed consent of the manufacturer. This warranty shall not apply to any batteries or accessories used in the equipment covered under this warranty or to any damage which may be caused by such batteries.

If the controller develops a fault, the product or main panel must be returned in adequate packing with:

1. a copy of your original invoice;
2. a description of any fault; and
3. contact name and information.

It is the purchasers responsibility to return the controller to the manufacture or their agent by prepaid freight.

KRAIN Manufacturing Corporation
Modular Irrigation Sprinkler Controller

Hereby, K-Rain Manufacturing Corporation declares that this irrigation controller Pro EX 2.0 is in compliance with the essential requirements and other provisions of Directive 1999/5/EC.



IP 24 Certified

Certificate of Conformity to
European Directives



K-Rain Manufacturing Corp.

ATTN: WARRANTY

1640 Australian Avenue

Riviera Beach, FL 33404

(561) 844-1002

(561) 842-9493 FAX

(800) 735-7246 / www.krain.com

© K-Rain Manufacturing Corp.
AN ISO 9001 CERTIFIED COMPANY
26005201 Rev. 07